

HANGZHOU JOY KITCHEN EQUIPMENT CO.,LTD

One-Stop Commercial Kitchen Solution

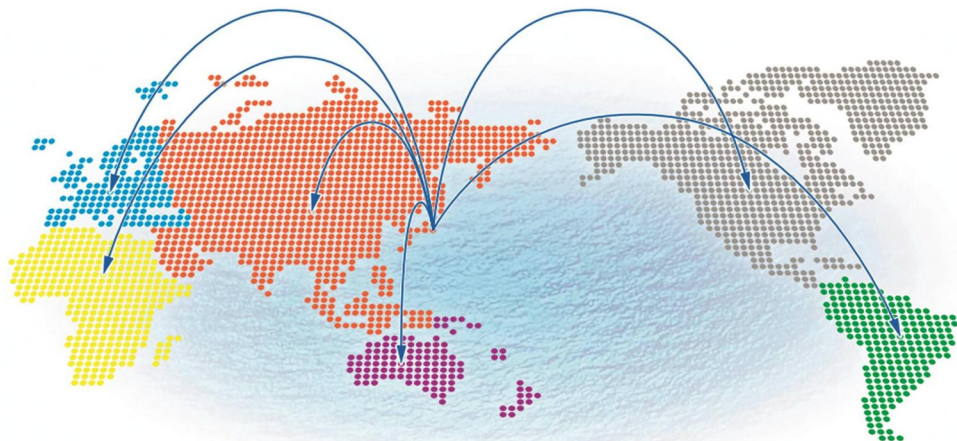

CONTACT US

Add: No 80 Pingshui West Street, Xihu District, Hangzhou, 310000, China

Web: www.joy-equipment.com

Email: info@joy-equipment.com

Phone: +86-18989455270 / +86-18329050253

Vacuum Marinator



Model Number	Capacity	Specification
YD-W35L 500USD	35 Liter tank 25KG capacity(20KG meat mix 5KG Marinated sauce)	110/220V 250W Dimension 890*445*700mm Computer Panel With vacuum marinated time 15-20 minutes
YD-W40L 550USD	40 Liter tank 30KG capacity(25KG meat mix 5KG Marinated sauce)	110/220V 250W Dimension 870*450*900mm Computer Panel With vacuum marinated time 15-20 minutes
YD-W60L 600USD	60 Liter tank 40KG capacity(35KG meat mix 5KG Marinated sauce)	110/220V 350W Dimension 921*455*850mm Computer Panel With vacuum marinated time 15-20 minutes
YD-W80L 650USD	80 Liter tank 50KG capacity(45KG meat mix 5KG Marinated sauce)	110/220V 350W Dimension 960*550*885mm Computer Panel With vacuum marinated time 15-20 minutes

Batter Breeding Machine



Round Baskets

Powder Wrapping Tank

Coarse Wet Powder Area

Casters

Manual Breeding Table



Item Name	Model Number	Specification
0.8M Manual Breeding Table	JF021A 100USD	800*700*920 (mm) Full body stainless steel With 2 baskets
1.0M Manual Breeding Table	JF021B 120USD	1000*700*940 (mm) Full body stainless steel With 2 baskets
1.2M Manual Breeding Table	JF021C 180USD	1200*700*940 (mm) Full body stainless steel With 3 baskets

Item Name	Model Number	Specification
Batter Breeding Machine	JF022 1,000USD	Voltage:220/110V 0.35KW Dimension: 1150*450*890mm Net weight 60KG Comes with brush
Double Batter Breeding Machine	JF022-2 2,000USD	Volatge 220/110V 0.2KW*2 Dimension: 2060*815*890+355mm Net weight 155kg Comes with brush



Why Choose a Pressure Fryer?

Pressure frying produces the most consistently flavorful product and is faster than any other method when cooking in higher volumes. With a pressure fryer, you're ensuring that moisture and flavor will be sealed in while excess cooking oil will be sealed out — yielding a healthier, more delicious final product. It's the ideal way to cook freshly breaded, bone-in items like chicken or other proteins with natural juices.

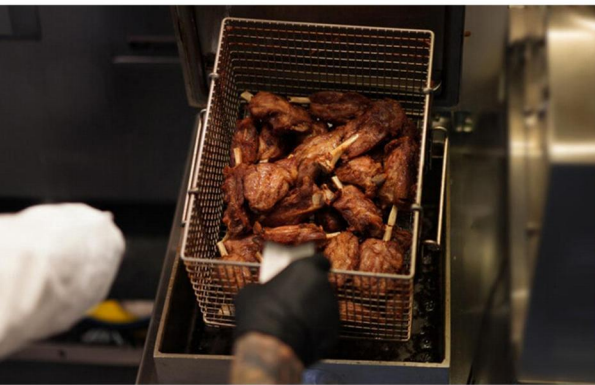

Model FB-1 Open Style



Model FB-2 Layered Type



Specification



The price comes with 2 baskets

Item Name	Model Number	Dimension(mm)	Net weight (KG)	Oil Capacity (Liter)	Volatage	Hz	Electric Power	Heating Power Source	Temperature	Built-in Oil Filtration System
GAS Pressure Fryer	PFG-600 1,800USD	500*1030*1180	170	25	1 Phase 110-120v 1 Phase 208-250V	50/60	0.5KW	If use LPG(0.48KG/H) If use Natural gas (0.68m³/h)	50-200 ℃	Yes
ELECTRIC Pressure Fryer	PFE-500 1,600USD	470*920*1150	150	25	3 Phase 380-440V 3 Phase 208-240V	50/60	13.5KW	Electric only	50-200 ℃	Yes

4-Head Pressure Fryers

4-head pressure fryers are the best-selling pressure fryers in the market. Especially the model PFG-600 and model PFE-500. They are same appearance and function. Just different power source. PFG-600 is Gas fryer, PFE-500 is Electric fryer. Learn more below.

Lid lock and seal

lid lock and color-coded spindle makes it easy to operate fryer safely

Energy efficient

High efficiency heating elements produce fast recovery

Frying time

In just 6-8 minutes, you can get a whole basket of fried chicken, crispy and juicy

25 Liter Oil Capacity

4 Head Whole Bone-in Chicken
/ 32 -36 pcs Chicken Wings, Legs

Programmable

Computron 8000 with full programming and oil management features

Built-in filtration

Fast, convenient filtering improves productivity and extends oil life



Model: PFG-600 / PFE-500

Why Choose an Open Fryer?

Commercial food service kitchens use open fryers instead of pressure fryers for a variety of menu items, including freezer-to-fryer items and foods that float while cooking.

You can see the process of fried frying more clearly. You can handle different foods at the same time, and the operation is simpler.



1 Pot 2 Baskets



OFE321/ OFG321

2 Pot 4 Baskets



OFE322/ OFG322

3 Pot 6 Baskets



OFE323/ OFG323

All the models comes with oil filtration system and memory programming panel

Electric Open Fryer ⚡

Model	Power	Voltage	Capacity	Dimension	Temperature range	Net weight	Gross weight
OFE-321	14.2kW	3N~380V/50Hz	25L	441×949×1180mm	20~190°C	128kg	148kg
OFE-322	27.7kW	3N~380V/50Hz	2×25L	882×949×1180mm	20~190°C	185kg	208kg
OFE-323	41.2kW	3N~380V/50Hz	3×25L	1323×949×1180mm	20~190°C	237kg	260kg

Gas Open Fryer 🔥

Model	Power	Voltage	Capacity	Dimension	Temperature range	Net weight	Gross weight
OFG-321	LPG or Natural Gas	220V/50Hz	25L	440×900×1130mm	20~190°C	138kg	158kg
OFG-322	LPG or Natural Gas	220V/50Hz	2×25L	850×900×1130mm	20~190°C	212kg	234kg
OFG-323	LPG or Natural Gas	220V/50Hz	3×25L	1250×900×1130mm	20~190°C	279kg	301kg

Remark: All voltage can change to US/CA standard

TUBE FRYER BURNERS

- High efficiency cast iron burners have a large heat transfer area.
- Tubes are constructed of heavy gauge metal with built-in deflector system.
- 30,000BTU (8.8KW)/Burner.
- Millivolt temperature control, 200°F-400°F (93°C-204°C)
- Fast recovery to desired temperature.
- Heats oil quickly producing a better tasting product with less oil absorption.
- 100% safety shut-off.



450 USD Model: GF14 (3 burner 20L oil capacity)
500 USD Model: GF40 (4 burner 25L oil capacity)

LARGE COLD ZONE

- Captures and holds food particles below the tubes, out of the fry zone.
- Reduces taste transfer.

OTHER FEATURES

- Tank is fully peened for smoother welds and easy cleaning.
- 2 large, nickel plated baskets with vinyl coated.
- 1-1/4" (32mm) full port drain valve for fast and complete oil draining.
- Drain pipe holder attached to inside door
- Stainless steel front and door.
- Stainless steel adjustable legs, casters options.
- One year parts and labor warranty.*



Model: MJ1CF (5 burner 40L oil capacity)

600 USD

Classic gas fryers

DIMENSIONS | SPECIFICATIONS | SHIPPING INFORMATION

Reinforced carton for shipping. Weight of carton included below, may vary from shipment to shipment. Shipped on a pallet.

	Dimensions						Cooking Area	Oil Capacity	No. Burners BTUs ea	Total BTUs	Net Wt	Ship Wt
	Width	Depth	Height	Legs Height	Gas Inlet Height	Drain Valve Height From Floor						
3 burner	15.5" (39.4cm)	31.3" (79.5cm)	45.7" (116.1cm)	6" (15.2cm)	6.6" (16.7cm)	16.25" (41.3cm)	14" x 14" (35.6 x 35.6cm)	40lbs (22kg)	3 30,000	90,000	120lbs (59.5kg)	150lbs (68kg)
4 burner	15.5" (39.4cm)	31.3" (79.5cm)	45.7" (116.1cm)	6" (15.2cm)	6.6" (16.7cm)	16.25" (41.3cm)	14" x 14" (35.6 x 35.6cm)	55lbs (30kg)	4 30,000	120,000	132lbs (65kg)	162lbs (73.5kg)
5 burner	21" (53.4cm)	35.4" (90cm)	45.5" (115.6cm)	6" (15.2cm)	6.6" (16.7cm)	16.25" (41.3cm)	18" x 18" (45.7 x 45.7cm)	80lbs (44kg)	5 30,000	150,000	168lbs (83kg)	209lbs (95kg)

Remark: Both Natural Gas & Propane Gas Model Are Available



Why Choose Holding Equipment?

Foodservice operators know that one of their most valuable resources is time — and any solution that helps free up employees to manage peak periods is priceless in a busy kitchen. That's the true benefit of having reliable holding equipment that keeps food ready to serve until it's needed, giving employees the ability to prepare food ahead of time in anticipation of the coming rush.

Double Tier With Water Filled Chicken Display



30-85°C

With Humidity Control

JF009	1200*760*860mm	450 USD
JF009A	1500*760*860mm	500 USD
JF009B	1800*760*860mm	600 USD

Model No.: JF009/ JF009A/ JF009B

- Full stainless steel construction for easy cleaning
- Pass-through design
- Angled thermo-perspex flip doors provide easy & clear viewing of the product as well as maximum heat retention which guarantees food safety & hygiene
- Individual control section giving the flexibility to adjust according to your needs
- Dry Heat top tier will give the heat require to hold your fried product crispy fresh
- Humidified Heat bottom tier will provide the humidified required to keep your product warmly moist and fresh
- Automatic water refilling thru the use of level sensor with manual by-pass
- Digital temperature display & thermostat control water in the well

NO.	Item Name	Picture	Model	Specification	Unit Price
1	Upright Insulated warming Cabinet		UHC-15	<p>Voltage: 1Phase 220V / 1 Phase 110V 50Hz /60Hz Power(kw):1.8 Temperature Range:30 -85°C Dimension(mm):630x800x1840mm Weight (kg):118 15 layer rack , inner size 430*630mm Capacity : 15 Pans or 15 *1/1GN tray Water tray inside to prevent loss of moisture, keep humid (also can remove water tray let it dry)</p> <p>Front 2 window door only By default, 15 pans are provided, as shown: Pans comes with removable wire rack.</p>	US\$1,350.00
2	Upright Insulated warming Cabinet Pass-through unit		UHC-15 (pass-thru)	<p>Voltage: 1Phase 220V / 1 Phase 110V 50Hz /60Hz Power(kw):1.8 Temperature Range:30 -85°C Dimension(mm):630x800x1840mm Weight (kg):120 15 layer rack, inner size 430*630mm Capacity : 15 Pans or 15 *1/1GN tray Water tray inside to prevent loss of moisture, keep humid (also can remove water tray let it dry)</p> <p>Front and back both doors, 4 window doors, pass through By default, 15 pans are provided, as shown: Pans comes with removable wire rack.</p>	US\$1,400.00
3	Countertop Insulated warming Cabinet		LZ-5	<p>Voltage: 1Phase 220V / 1 Phase 110V 50Hz /60Hz Dimensions: 636*808*985mm Net weight 65KG 7 layer rack, Capacity : 7 Pans or 7 *1/1GN tray 1.8KW Temperature Range:30 -85°C Water tray inside to prevent loss of moisture, keep humid (also can remove water tray let it dry)</p> <p>Front 1 window door only By default, 7 pans are provided, as shown: Pans comes with removable wire rack.</p>	US\$1,000.00
4	Countertop Insulated warming Cabinet Pass-through unit		LZ-5 (pass-thru)	<p>Voltage: 1Phase 220V / 1 Phase 110V 50Hz /60Hz Dimensions: 636*808*985mm Net weight 66KG 7 layer rack , Capacity : 7 Pans or 7 *1/1GN tray 1.8KW Temperature Range:30 -85°C Water tray inside to prevent loss of moisture, keep humid (also can remove water tray let it dry)</p> <p>Front and back both doors, 2 window doors, pass through By default, 7 pans are provided, as shown: Pans comes with removable wire rack.</p>	US\$1,050.00

Burger Bun Machines

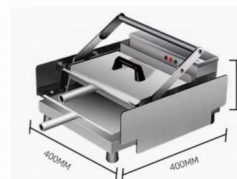

GF-211A



GF-212A



KDL-2621

Model Number	Item Name	Specification
GF-211A 120USD	6 Burger Toaster	<p>Dimension: 400*400*280mm 220V 50Hz 850W heating plate 320*200mm , 50-300 °C 12Kg weight Capacity 6 burgers Food grade Stainless Steel & Aluminum</p>
GF-212A 180USD	12 Burger Toaster	<p>Dimension: 650*400*280mm 220V 50Hz 2.4KW heating plate 440*320mm, 50-300 °C 20Kg weight Capacity 12 burgers Food grade Stainless Steel & Aluminum</p>
KDL-2621 550USD	Auto Continuous Burger Toaster	<p>Voltage:220V Power:1600W Weight:26kg Dimension:420*250*585mm Speed:5 -15S one burger</p>



Model Number	Item Name	Specification
TP350 300USD	Potato Washer+ Peeler 2 in1	Output: 240kg/h 710*500*830mm Full body Stainless steel 1 Phase 110V / 1 Phase 220V
TP450 350USD	Potato Washer+ Peeler 2 in1	Output: 400kg/h 750*590*950mm Full body Stainless steel 1 Phase 110V / 1 Phase 220V

Potato Washer+ Peeler 2 in1 Machine



Model Number	Item Name	Specification
TP350C 500USD	Potato Washer+ Peeler +Cutter 3 in1	Plus a french fries cutter base on TP350 Thickness 3-15mm fries, let me know what thickness you need Output: 200kg/h Full body Stainless steel 1 Phase 110V / 1 Phase 220V
TP450C 550USD	Potato Washer+ Peeler +Cutter 3 in1	Plus a french fries cutter base on TP450 Thickness 3-15mm fries, let me know what thickness you need Output: 350kg/h Full body Stainless steel 1 Phase 110V / 1 Phase 220V

Potato Washer + Peeler + Cutter 3 in 1 Machine



FC-1



FC-2

Model Number	Item Name	Specification
Manual Fries Cutter FC-1 50USD	FC-1	21*29*24cm 3.5KG Comes with 3 molds (6 /9 /13mm thickness)
Manual Fries Cutter FC-2 50USD	FC-2	28*18*35cm 3.5KG Comes with 3 molds (7/10 /14mm thickness)

Manual Fries Cutter

Fries Dump Station Warmer



JF020 / JF020-1



JF072



JF072-A



型号 Model	名称 Name	规格 Size	电压 Volts	功率 Power
120USD JF020	French Fries/Chips Warmer	600*710*680mm	220/ 110V	650W
150USD JF020-1	French Fries/Chips Warmer	800*710*680mm	220/ 110V	650W
400USD JF072	French Fries/Chips Warmer	600x700x1500mm	220/ 110V	750W
500USD JF072-A	French Fries/Chips Warmer	1000x700x1570mm	220/ 110V	850W

Package



Model PK-1 Takeout bags



PK-2 Chicken box



PK-3 Chicken bucket

Let us know your requirements and order amount



PK-10 Paper liner



PK-4 Burger box



PK-9 Fries pouch



JF Series Grinder not good for frozen meat

Item Name	Model Number	Specification
Electric Meat Grinder	JF006 90USD	290*170*340mm GW:12KG 500w Output:70kg/h Material :Spray paint
	JF006A 130USD	290*170*340mm GW:12.5KG 500w Output: 70kg/H Material :304 stainless steel
	JF006B 110USD	380*220*420mm GW:22KG 850w Output:120kg/H Material :Spray paint
	JF006C 150USD	380*220*420mm GW:23KG 850w Output:120kg/H Material :304 fstainless steel
	JF006D 160USD	530*360*550mm GW:26.5KG 1200W Output: 220kg/h Material :Spray paint
	JF006E 190USD	530*360*550mm GW:28KG 1200W Output:220kg/h Material :304 stainless steel



JR32A / JR42A / JR52A



MEAT GRINDER

GY500A / GY1500A

Mincing machine can mince all kinds of meat, frozen meat, fruits and vegetables, pepper, ginger and garlic, etc.

Model No.	Voltage	Power	Output	Dimension	Weight
XAT-JR32A	700USD 380/220v	2.2/1.5kw	150-320kg/h	400x700x840mm	90kg
XAT-JR42A	1,000USD 380v	3kw	300-600kg/h	1100x540x1070mm	100kg
XAT-JR52A	1,700USD 380v	7.5kw	800-1300kg/h	800x1350x1220mm	175kg

Model No.	Voltage	Power	Output	Dimension	Weight
XAT-GY500A	380v	5.5kw	500-800kg/h	680x500x1020mm	350kg
XAT-GY1500A	380v	11kw	1500-5000kg/h	1325x800x1200mm	600kg

GENERAL FEATURE:

- A durable polished, anodized aluminum body construction
- SUS 304 stainless press bowl and press plate
- Heavy-duty, single-level press handle
- Detachable wax paper divider holder
- Compact, simple & ergonomic design
- Manually operated

Manual Beef Patty Maker



TECHNIC PARAMETERS:	100USD	105USD	110USD
MODEL:	HPP100-MA	HPP130-MA	HPP150-MA
PLATE SIZE:	100mm	130mm	150mm
MACHINE SIZE:	28.5x19.5x27.5cm	28.5x19.5x27.5cm	28.5x19.5x27.5cm
N.W./G.W.:	4.5/5.0 kg	5.0/5.5 kg	5.5/6.0 kg
PACKING SIZE:	31X23.5X28.5cm	31X23.5X28.5cm	31X23.5X28.5cm

Electric Contact Grill



CG-811
90USD



CG-811B
80USD



CG-811E
120USD

型号 Model	CG-811	CG-811B	CG-811E
产品规格 Size	310×380×220mm	310×380×220mm	430×370×220mm
电压 Volts	220V~240V	220V~240V	220V~240V
功率 Power	1.8kW	1.8kW	2.2kW
净重 Net Weight	13kg	13kg	20kg



CG-812B
100USD



CG-813
160USD



CG-813B
160USD

型号 Model	CG-812B	CG-813	CG-813B
产品规格 Size	430×370×220mm	580×380×220mm	580×380×220mm
电压 Volts	220V~240V	220V~240V	220V~240V
功率 Power	2.2kW	1.8kW	3.6kW
净重 Net Weight	20kg	13kg	28kg

Electric Clamshell Griddle



Item Name	Picture	model	Specification
Automatic lifting Electric Clamshell griddle Grill		JEG-822 5,600USD	Product dimension:650*920*750+200mm Voltage: 3 Phase 380V / 3 Phase 220V Power of : 10*2 KW Power of base plate: 6kw*2 Upper plate:4kw*2 Dimension of base grid:644*610*21.5mm Dimension of Upper grid platform :280*580*120mm *2 Temperature range:30°C-280°C Precise temperature control and timing Upper handle with anti-scalding rubber sleeve With auto lifting function Remark: 3 Phase 220V plus 200USD
Electric Clamshell griddle Grill		JEG-820 2,900USD	Product dimension:550*720*850+150 mm Voltage: 3 Phase 380V / 3 Phase 220V Power : 12 KW Power of base plate: 8KW Upper plate:2kw*2 Dimension of base plate:545*450*20mm Dimension of Upper plate :225*410*120mm*2 Temperature range:30°C-280°C Precise temperature control and timing Upper handle with anti-scalding rubber sleeve Remark: 3 Phase 220V plus 200USD

For indoor commercial use only.

Gas Griddles-Countertop

STANDARD FEATURES

- Alpha brass control components.
- Stainless steel front, ledge, sides.
- Double wall insulated sides.
- 3/4"(19mm) griddle plate standard, 1" options.
- 30,000BTU (8.8KW)/Burner.
- "U" shape burners provide even heat distribution every 12".
- Back and side splash guards fully welded to griddle plate.
- Easy to remove 3-1/4"(82mm) grease drawer
- with "weep hole" and baffle.
- Grease through is standard 4" spatula width.
- Griddle is fully serviceable from the front.
- Flue located on back of unit for ample ventilation.
- Adjustable stainless steel legs, non-skid feet.
- Unit ships natural gas with liquid propane gas (LP)conversion kit and regulator.
- Flame failure protection options.
- One year parts and labor warranty.*



AG12



AG24



AG36



AG48



AG60

DIMENSIONS | SPECIFICATIONS | SHIPPING INFORMATION

Reinforced wooden package for shipping. Weight of wooden package included below, may vary from shipment to shipment.
Shipped on a pallet.

220USD
400USD
550USD
800USD
1,100USD

Model	Width	Depth	Height	Net Wt	No. Burners BTUs ea	BTUs (Total)	Cooking Area	Shipping Dimensions	Ship Wt
AG12	12" (30.7cm)	28.5" (72.4cm)	15.5" (39.4cm)	88lbs (40kg)	1 30,000	30,000	12" x 20" (30.7 x 51 cm)	16.1" W x 36.2" D x 19.3" H (41 x 92 x 49cm)	121lbs (55kg)
AG24	24" (61cm)	28.5" (72.4cm)	15.5" (39.4cm)	144lbs (71kg)	2 30,000	60,000	24" x 20" (61 x 51 cm)	28.3" W x 36.2" D x 19.3" H (72 x 92 x 49cm)	196lbs (89kg)
AG36	36" (91cm)	28.5" (72.4cm)	15.5" (39.4cm)	202lbs (100kg)	3 30,000	90,000	36" x 20" (91 x 51 cm)	40.6" W x 36.2" D x 19.3" H (103 x 92 x 49cm)	284lbs (129kg)
AG48	48" (121cm)	28.5" (72.4cm)	15.5" (39.4cm)	255lbs (126kg)	4 30,000	120,000	48" x 20" (121 x 51 cm)	52.8" W x 36.2" D x 19.3" H (134 x 92 x 49cm)	355lbs (161kg)
AG60	60" (152.8cm)	28.5" (72.4cm)	15.5" (39.4cm)	340lbs (154kg)	5 30,000	150,000	60" x 20" (152.8 x 51 cm)	64.8" W x 36.2" D x 19.3" H (165 x 92 x 49cm)	417lbs (189kg)

3/4" NPT gas connection.
Natural gas 4" W.C. , LP gas 10" W.C.
Available in natural and liquid propane gas models.

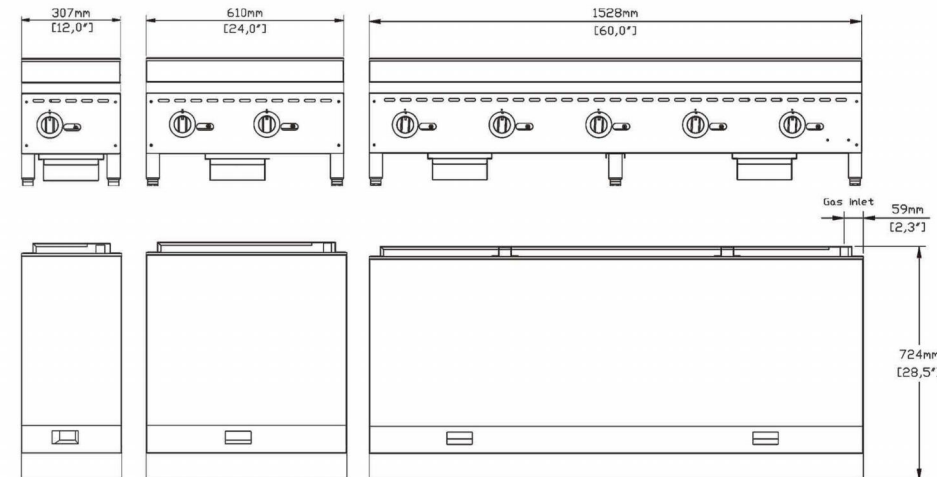

Gas griddle is constructed of stainless steel with extra-insulation in front and side walls; with cool-to-touch front edge.

Griddle plate is 1" thick options, highly polished steel with 3.5" tapered wraparound stainless steel splash guard. Griddle has a 4" wide front grease trough with grease chute and a stainless steel grease drawer with weep holes.

Unit has high performance 30,000 BTU stainless steel U-style burners to provide flame every 6". A standing pilot is provided on manual control griddles. Gas connection is 3/4" N.P.T. males and a convertible pressure regulator is provided for either LP or natural gas. Griddle is listed to NSF Standard 4 by CSA.

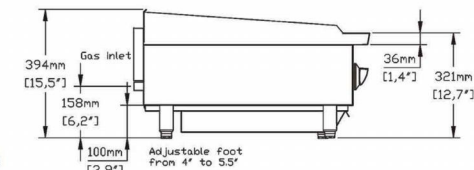

Gas Charbroiler



CG-48A



CG-36A

型号 Model:	CG-48A 500USD	CG-36A 400USD
外形尺寸 Dimensions	1220×770×370mm	860×770×370mm
热功率 Power	58.6KW(202170BTU)	44KW(151800BTU)
燃烧器数 Number	8	6
净重 Net weight	174kg	134kg

Gas Salamander



CG-16 (6 burner)



CG-18 (8 burner)



CG-20 (10 burner)

型号 Model	CG-16 400USD
产品规格 Size	860×530×610mm
功率 Power	12.7kW
净重 Net Weight	38kg
型号 Model	CG-18 500USD
产品规格 Size	1070×530×610mm
功率 Power	17kW
净重 Net Weight	50kg
型号 Model	CG-20 600USD
产品规格 Size	1280×530×610mm
功率 Power	21kW
净重 Net Weight	65kg

Gas Chicken Rotisserie



Parameter of product

Each layer can load 5 pcs whole chicken

400USD
550USD
700USD
850USD
1000USD
1,150USD
1,300USD

Model	Name	Specification	Dimension(mm)	Burners QTY	Gas consumption
WJ-2	Rotisserie Oven	2 layers	1380*500*660	2	0.8Kg/h
WJ-3	Rotisserie Oven	3 layers	1380*500*860	3	1.2Kg/h
WJ-4	Rotisserie Oven	4 layers	1380*500*1060	4	1.6Kg/h
WJ-5	Rotisserie Oven	5 layers	1380*550*1260	5	2.0Kg/h
WJ-6	Rotisserie Oven	6 layers	1380*500*1460	6	2.4Kg/h
WJ-7	Rotisserie Oven	7 layers	1380*500*1660	7	2.8Kg/h
WJ-8	Rotisserie Oven	8 layers	1380*500*1925	8	3.2Kg/h

Model WJ-6 Contour map as below(Other models' contour map is similar:

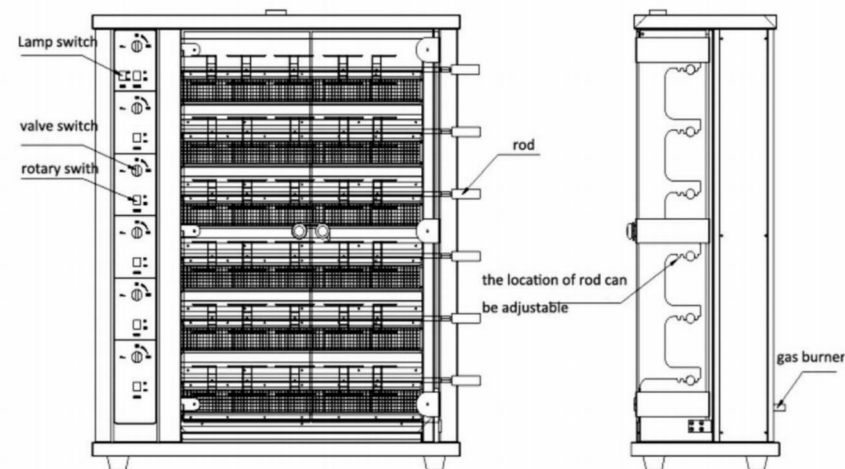



Product Features

Digital Controls

Programmable controls with digital temperature display.

One-piece Drawer Pans

Heavy-duty thermoplastic drawer pans for convenient product access.

Removable Pan Lid

One section features pan lid for retaining humidity.

Separate Holding

Two tiers with separately controlled holding environments.

Dual Access

Dual access models use tray pans with handles at both ends.

Modular Warming Cabinet

All comes with CAMBRO Trays

Holding Cabinet (Pass-Through Countertop Type)

FEATURES:

- LED digital display clearly indicates parameter for easy reading.
- Built-in microcomputer controller to set temperature respectively for each layer and independent power switch for each layer saves power consumption cost by turning off switch for layer not being used.
- Each layer (front and back) is equipped with 2 independent timers to set warming time between 1 second to 99 minutes 59 seconds for different kinds of foods. Each time controller will not affect other timers' operation. Special design for crispy or moist food by different layer storage.
- Alarm alert gives signal to remind warming time.
- WTC heat patch and aluminum heating plate make heating evenly and constant to efficiently save power consumption up to 30%.
- Front and back pass-through food access with timer indicating the same warming time.
- Durable stainless steel body is easy to clean.
- Heat tolerance is up to 190°C, securing food safety.







HB-4 4 layer 4 big tray



HB-2 2 layer 6 trays

Product Name	Model	Dimension(W*D*H)	Power	Capacity	Temp. Range	Weight
2-Layer Holding Cabinet (Pass-Through Countertop Type)	1, 540USD HB-2	820*400*320(mm)	220V 50Hz 2.0kW	2-Layer	Room Temp. to 100°C	49kg
4-Layer Holding Cabinet (Pass-Through Countertop Type)	1, 900USD HB-4	515*627*680(mm)	220V 50Hz 3.6kW	4-Layer	Room Temp. to 100°C	102kg

Economic affordable style

Model No.	Product Photos	Description	Unit Size mm
HC-2 980USD		2 layers holding cabinet with 6 pieces palstic pans,unit size : 720x400x320mm, 220v, 1kw,each layer with independent digital control panel . and each layer top with heating film to heat ,very stable. temperature rane :30-80 °Ccelsius degree.	720x400x320mm
HD-2 1, 120USD		2 layers holding cabinet with 6 pieces palstic pans, front and back each pan with 2 timer ,total with 12 timers. unit size : 720x400x320mm, 220v, 1kw,each layer with independent digital control panel . and each layer top with heating film to heat ,very stable. temperature rane :30-80 °Ccelsius degree.	720x400x320mm
HE-2 810USD		2 layers holding cabinet with 4 pieces palstic pans ,unit size : 560x400x320mm, 220v, 0.8kw,each layer with independent digital control panel . and each layer top with heating film to heat ,very stable. temperature rane :30-80 °Ccelsius degree.	560x400x320mm
HF-2 910USD		2 layers holding cabinet with 4 pieces palstic pans. front and back each pan with 2 timer ,total with 8 timers ,unit size : 560x400x320mm, 220v, 0.8kw,each layer with independent digital control panel . and each layer top with heating film to heat ,very stable. temperature rane :30-80 °Ccelsius degree.	560x400x320mm
HD-3 1, 400USD		3 layers holding cabinet with 9 pieces plastic pan. front and back each pan with 2 timer ,total with 1 8 timers . included add heating element on the second layer buttom,all layers can keep warm more well .and also included add timer	720x400x480mm

SPIRAL MIXER

The mixing process is the first step of making great dough – and it's a critical one.

Spiral mixers are designed to gently knead doughs – perfect for breads, pastries and Neapolitan pizza dough.

Excels at 55%-70% Dough Hydration

Most Popular Models

Speed Control



Easy-to-Use Control Panel

This spiral dough mixer has an intuitive control panel that includes a timer, which will keep careful track of how long the mixer churns and prevent the dough from becoming overworked.



Auto-Stop Failsafe

As a built-in precaution, the mixer has an auto stop failsafe that will turn off the unit once the timer hits zero, which is helpful for when employees are preoccupied with other tasks throughout the kitchen.



Below are the imperial weights of a sack of flour as sold in stores in the **USA**

Bulk sack of flour weight (as sold)	Weight in ounces	Metric conversion
20lb	320oz	9072g / 9.1kg
25lb	400oz	11340g / 11.3kg
50lb	800oz	22680g / 22.7kg

Sacks of flour are sold in metric weights in most countries across the world (**UK, EU, AU, etc**), the chart shows common sack weights and along with conversions into imperial:

Sack of flour weight (as sold)	Weight in grams	Imperial conversion
16kg	16,000g	564.4oz / 35.3lb
25kg	25,000g	882oz / 55.1lb

Sack of flour weight



Grated Lid for Safety

Conveyor Belt Pizza Ovens



This is an affordable Conveyor Belt Oven. Heated at the top and bottom, control the temperature separately. The speed and direction of the belt can be adjusted. Have 6 models can be chosen, see below.

Model Number	Item Name	Dimension	Baking Room (W*L)	Voltage	Temperature
JB098 1,400USD	18" Gas Conveyor Oven	1720*890*560mm	540*845mm	1 Phase 110V 1 Phase 220V	50-400°C
JB099 2,000USD	26" Gas Conveyor Oven	1925*1115*560mm	690*1040mm	1 Phase 110V 1 Phase 220V	50-400°C
JB100 2,400USD	32" Gas Conveyor Oven	2080*1260*560mm	860*1200mm	1 Phase 110V 1 Phase 220V	50-400°C
JB101 1,100USD	18" Electric Conveyor Oven	1560*750*370mm	540*800mm	3 Phase 220V 3 Phase 380V	50-400°C
JB102 1,700USD	26" Electric Conveyor Oven	1780*920*370mm	690*1040mm	3 Phase 220V 3 Phase 380V	50-400°C
JB103 2,000USD	32" Electric Conveyor Oven	1900*1120*370mm	860*1200mm	3 Phase 220V 3 Phase 380V	50-400°C

MODEL	POWER	DIMENSION(mm)	CAPACITY	CAPACITY	N.W(KG)
			Bowl / Dry Flour	Dough / Bowl	
HS20	480USD 1.5 kW	730*390*900mm	20L/8kg	30 lb. / 20 qt.	90kg
HS30	580USD 1.5 kW	730*390*900mm	34L/12kg	45 lb. / 30 qt.	100kg
HS40	650USD 3 kW	800*480*970mm	45L/16kg	60 lb. / 40 qt.	115kg
HS50	800USD 3 kW	850*510*970mm	54L/20kg	75 lb. / 50 qt.	125kg
HS60	880USD 3 kW	850*510*970mm	64L/25kg	90 lb. / 60 qt.	130kg
HS80	1,600USD 3.2 kW	880*560*1100mm	80L/33kg	120 lb. / 80 qt.	250kg
HS1001	800USD 4.1 kW	1080*650*1380mm	100L/40kg	150 lb. / 100 qt.	340kg

Gas Convection Oven

For indoor commercial use only.

STANDARD FEATURES

- 3 inshot burners-18,000BTU (5.3KW) each.
- Temperature range:150°F-500°F (66°C -260°C).
- Stainless steel front, side and top.
- Independent doors with full view windows.
- Porcelain enamel oven interior.
- 10 position interior rack guides.
- 5 nickel plated oven racks.
- 2-speed, 1/2hp fan motor (1725,1140rpm).
- 2 halogen interior lights.
- Electronic ignition (Fenwal).
- Electronic thermostat and manual timer controls.
- Control panel opens downward for easy service.
- Oven ready light.
- Forced "cool down" fan mode.
- One year parts and labor warranty.*



ACO1
with Leg and Caster Kit

Gas model 2,000USD
Electric model 1,800 USD

DIMENSIONS SPECIFICATIONS SHIPPING INFORMATION				
Reinforced wooden package for shipping. Weight of wooden package included below, may vary from shipment to shipment. Shipped on a pallet.				
Model	Overall Dimensions	Oven Interior	Rack Clearance	Shipping Crate(s)
ACO1	38"W x 44.5"D x 61.7"H	29"W x 22.5"D x 19.37"H	28"W x 21"D	45.3"W x 49.2"D x 37"H, 48 cu ft, 511lbs
ACO2	38"W x 44.5"D x 68.8"H	29"W x 22.5"D x 19.37"H	28"W x 21"D	2 single oven crates, 96 cu ft, 1022lbs

Single oven leg and caster kit: 18.1"W x 29.9"D x 8.7"H, 2.7cu ft, 41lbs. (46x76x22cm, 0.07m³, 18.5kg)
Dual oven stacking kit: 11.8"W x 38.2"D x 6.7"H, 1.7cu ft, 35lbs. (30x97x17cm, 0.04m³, 16kg)

Both Natural Gas & Propane Gas Types Are Available

3/4" NPT gas connection
Built NG with LP conversion kit included.
Natural gas 5"W.C. , LP gas 10" W.C.
Electrical: 120V 50/60HZ or 220V 50/60HZ.

GAS SINGLE CONVECTION OVEN

Model: ACO1
Dimensions: 965x1130x1570mm
Interior: 740x570x50mm
Rack: 720x540mm
Shipping: 1150x1250x990mm,232kg



GAS DUAL CONVECTION OVEN

Model: ACO2
Dimensions: 965x1130x1750mm
Interior: 740x570x50mm
Rack: 720x540mm
Shipping: 2 single oven crates,564kg



Gas model 3,600USD
Electric model 3,300 USD
ACO2
with Stacking Kit

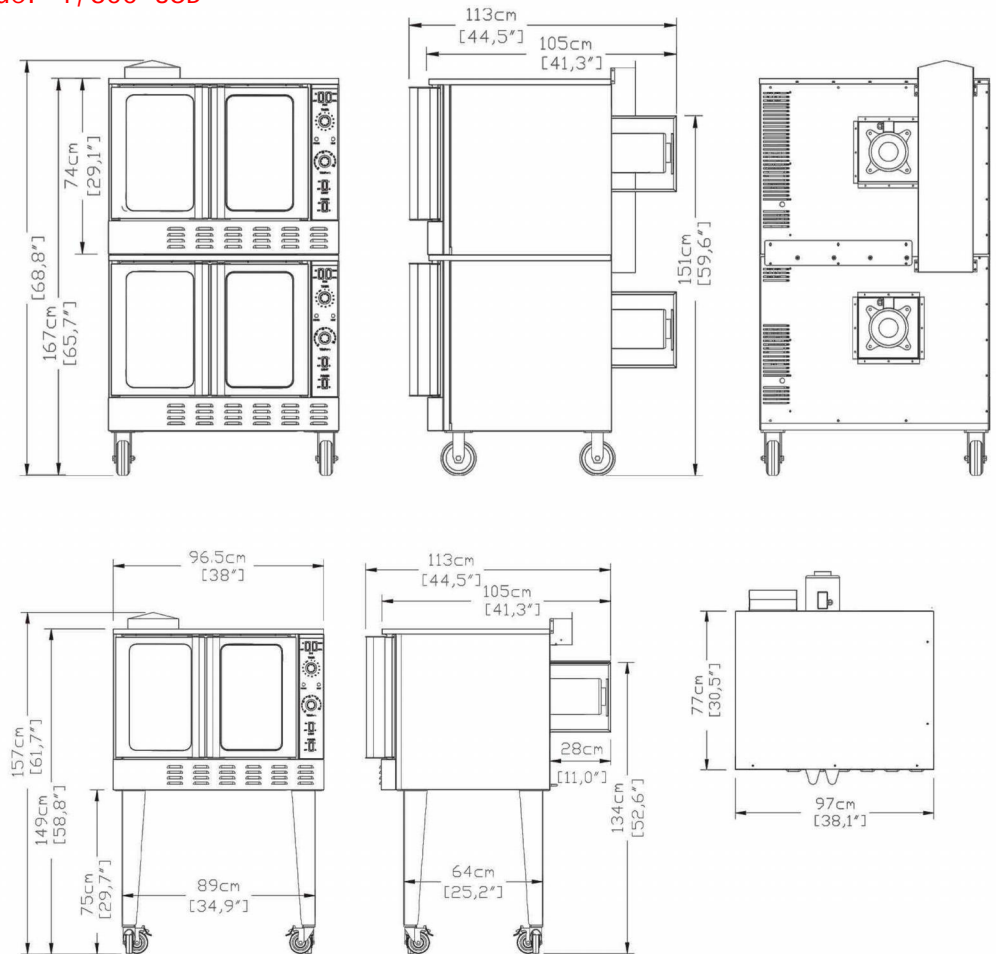

For indoor commercial use only.

Gas Range-Open Burner under Oven

Also can make holding cabinet instead of under oven

STANDARD FEATURES

- Alpha brass control components.
- Stainless steel front, back riser, lift off shelf.
- Heavy-duty cast iron grates with aeration bowl.
- Standing pilot light for individual burners.
- Manual gas control.
- 30,000BTU (8.8KW)/Burner.
- 33,000BTU (9.7KW) Static oven.
- Oven interior side guides and bottom porcelain coated.
- Oven thermostat adjusts from 200°F -500°F (93°C -260°C).
- Oven with 2 racks, 3 positions.
- Flue located on back of unit for ample ventilation.
- Easy to remove full width crumb tray.
- Range is fully serviceable from the front.
- Stainless steel legs standard, casters options.
- One year parts and labor warranty.*

Backsplash is Optional



AR24



AR48

AR36

AR60

DIMENSIONS | SPECIFICATIONS | SHIPPING INFORMATION

Reinforced wooden package for shipping. Weight of wooden package included below, may vary from shipment to shipment.

Shipped on a pallet.

Model	Description	Total BTU	KW	Oxerall Dimensions	Weight	Shipping Dimensions	Ship Wt
AR24	24" Range- 4 top burners	153,000NG 136,000LPG	45 40	24" x 31.4" x 60" (61.3 x 79.7 x 150.1cm)	255lbs 126kg	27.6" x 36.2" x 43.8"	354lbs
AR36	36" Range- 6 top burners	213,000NG 190,000LPG	63 56	36" x 31.4" x 60" (91.7 x 79.7 x 150.1cm)	332lbs 164kg	39.4" x 36.6" x 43.8"	467lbs
AR48	48" Range- 8 top burners	306,000NG 272,000LPG	81 72	48" x 31.4" x 60" (122.3 x 79.7 x 150.1cm)	488lbs 222kg	51.2" x 36.6" x 43.8"	643lbs
AR60	60" Range- 10 top burners	366,000NG 326,000LPG	99 88	60" x 31.4" x 60" (152.8 x 79.7 x 150.1cm)	567lbs 280kg	63" x 36.6" x 43.8"	749lbs

900USD

1,100USD

1,500USD

1,800USD

3/4" NPT gas connection.
Natural gas 4" W.C. , LP gas 10" W.C.
Available in natural and liquid propane gas models.

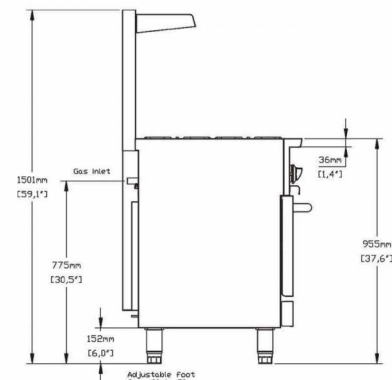
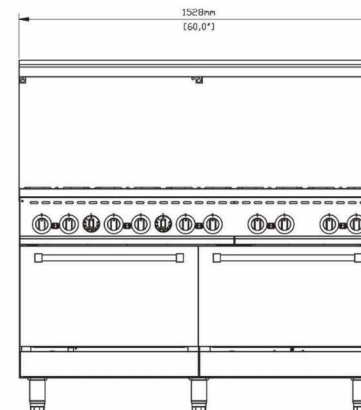
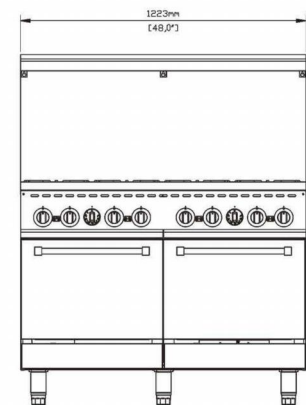
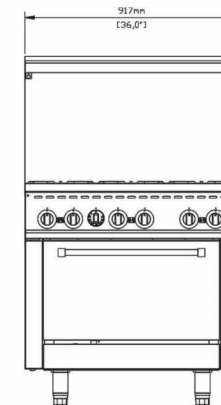
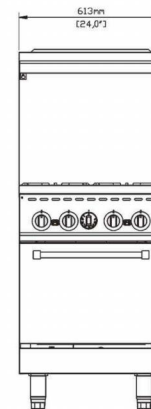

For indoor commercial use only.

Gas Hot Plates—Countertop

The Aflame gas countertop line includes hot plates, charbroilers, griddles that can be adjusted to line up with even height for a great appearance in any cooking application. With robust construction, continuous output and operator friendly controls, Aflame equipment meets all commercial cooking demands!

STANDARD FEATURES

- Alpha brass control components.
- Stainless steel front, ledge, sides.
- Double wall insulated sides.
- Heavy-duty cast iron grates remove easily and safely.
- Aeration bowl in each grate to retain heat to each pot/pan.
- 25,000BTU (7.3KW)/Burner.
- Octagonal cast iron burners.
- Standing pilot light for each burner.
- Adjustable pilot lights.
- Adjustable stainless steel legs, non-skid feet.
- Full length seamless drip pan, easy to remove and clean.
- Unit ships natural gas with liquid propane gas (LP) conversion kit and regulator
- Flame failure protection options.
- One year parts and labor warranty.*



AH12



AH24



AH36

DIMENSIONS | SPECIFICATIONS | SHIPPING INFORMATION

Reinforced wooden package for shipping. Weight of wooden package included below, may vary from shipment to shipment.

Shipped on a pallet.

240USD

400USD

600USD

Model	Width	Depth	Height	Net wt	No. Burners BTUs ea	BTUs (Total)	Shipping Dimensions	Ship Wt
AH12	12" (30.8cm)	28.4" (72cm)	13" (32.9cm)	50lbs (24.5kg)	2 25,000	50,000	16.1" W x 35.4" D x 17.7" H (41 x 86 x 45cm)	79lbs (36kg)
AH24	24" (61cm)	28.4" (72cm)	13" (32.9cm)	88lbs (43.5kg)	4 25,000	100,000	28.3" W x 35.4" D x 17.7" H (72 x 90 x 45cm)	132lbs (60kg)
AH36	36" (91.5cm)	28.4" (72cm)	13" (32.9cm)	126lbs (62kg)	6 25,000	150,000	40.6" W x 36.2" D x 17.7" H (103 x 92 x 45cm)	198lbs (90kg)

3/4" NPT gas connection.
Natural gas 4" W.C. , LP gas 10" W.C.
Available in natural and liquid propane gas models.

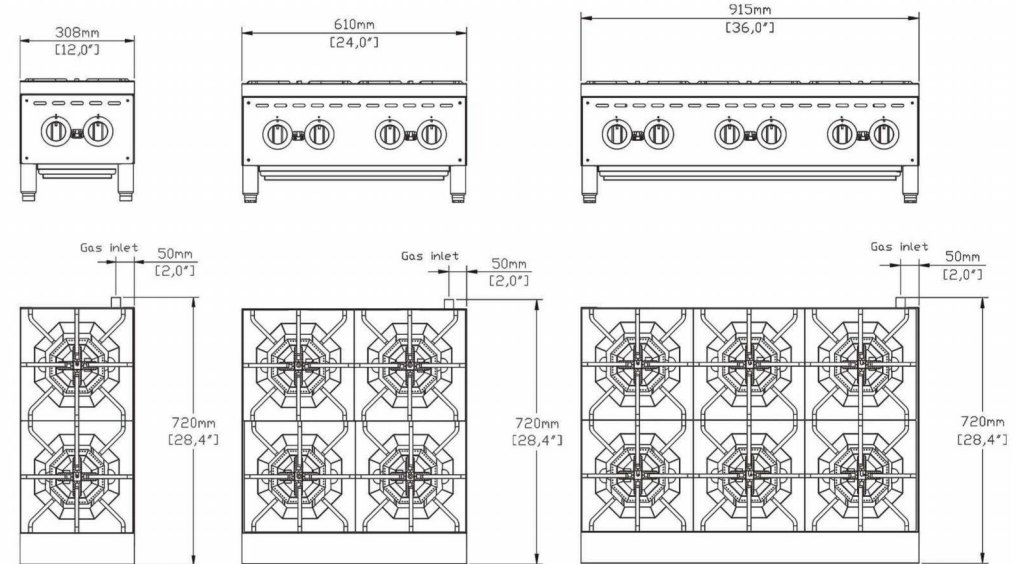

Gas hot plate is constructed of stainless steel front plate and frame with cool-to-touch front edge. Unit has extra insulation on front and side walls, with high performance 25,000 BTU cast iron burners and adjustable pilot lights with front access. Burner grates are heavy duty cast iron, catch tray is stainless steel and removable. Gas connection is 3/4" N.P.T. males and a convertible pressure regulator is provided for either LP or natural gas. Hot plate is listed to NSF Standard 4 by CSA.

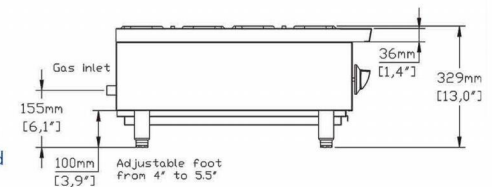

Warming Showcase



R60

R90

R120

Curved Food Warming Showcase R60 120USD R90 180USD R120 240USD

规格 (Size)	660*480*640mm	900*480*640mm	1200*480*640mm
电压 (Volts)	220V	220V	220V
功率 (Power)	1KW	1.8KW	2KW
净重 (Net weight)	32kg	41kg	56kg

Electric Bain Maire Food Warmer



Glass Cover
Model ST004-1 / ST005-1



Free combination of three types of pans



ST-004



ST-005

Model Number	Item Name	Specification
ST004 500USD	Electric Bain Marie 4 Pans (1/1GN)	1500*680*800mm 304SS GN trays with lid 220V/110V , 2KW You can use 1/2GN or 1/3GN Trays as well, let me know how you pick
ST-005 550USD	Electric Bain Marie 5 Pans (1/1GN)	1800*680*800mm 304SS GN trays with lid 220V/110V , 2.2KW You can use 1/2GN or 1/3GN Trays as well, let me know how you pick
ST004-1 100USD	Glass Cover for ST004	Tempered glass and stainless steel material
ST005-1 120USD	Glass Cover for ST005	Tempered glass and stainless steel material

Vacuum Packing Machine

Desktop vacuum machine
DZ-260PD 500USD
Power: 0.5kw;Voltage/frequency: 110-120v / 60hz
Vacuum pressure: 0.1 mpa
Heat seal width: 8 mm
Vacuum displacement: 10 m ³ /hr
Vacuum chamber size: 280 * 380 * 50MM
Machine size: 330 * 500 * 350mm
Gross weight/net weight:40/34 kgs
Outer package size: 490 * 440 * 480mm



Desktop vacuum machine
DZ-300PD 520USD
Power: 0.5kw;Voltage/frequency: 110-120v / 60hz
Vacuum pressure: 0.1 mpa
Heat seal width: 8 mm
Vacuum displacement: 10 m ³ /hr
Vacuum chamber size: 320 * 380 * 50MM
Machine size: 370 * 500 * 350mm
Gross weight/net weight:42/40 kgs
Outer package size: 650 * 550 * 420mm



Desktop vacuum machine
DZ-400/2F 580USD
Power: 0.75kw;Voltage/frequency: 110-120v / 60hz
Vacuum pressure: 0.1 mpa
Heat seal width: 10 mm
Vacuum displacement: 20 m ³ /hr
Vacuum chamber size: 430 * 420 * 65MM
Machine size: 540 * 490 * 430mm
Gross weight/net weight:85/65 kgs
Outer package size: 580 * 610 * 550mm





Single chamber vacuum machine
DZ-B400/2E 600USD
Power: 0.75kw;Voltage/frequency: 110-120v / 60hz
Vacuum pressure: 1.33 mpa
Heat seal width: 10 mm
Vacuum displacement: 20 m ³ /hr
Vacuum chamber size: 430 * 420 * 65MM
Machine size: 540 * 500 * 950mm
Gross weight/net weight:120/100 kgs
Outer package size: 600 * 570 * 1000mm





Vacuum Packing Machines

Single chamber vacuum machine	
DZ-A400/2E 600USD	
Power: 0.75kw;Voltage/frequency: 110-120v / 60hz	
Vacuum pressure: 1.33 mpa	
Heat seal width: 10 mm	
Vacuum displacement: 20 m ³ /hr	
Vacuum chamber size: 430 * 420 * 65MM	
Machine size: 540 * 500 * 950mm	
Gross weight/net weight:120/100 kgs	
Outer package size: 600 * 570 * 1000mm	

Double chamber vacuum machine	
DZ-400/2SB 1,100USD	
Power: 0.75kw;Voltage/frequency: 110-120v / 60hz	
Vacuum pressure: 1.33 mpa	
Heat seal width: 10 mm	
Vacuum displacement: 20 m ³ /hr	
Vacuum chamber size: 500 * 450 * 50MM (unilateral)	
Machine size: 1100 * 540 * 950mm	
Gross weight/net weight:150/130 kgs	
Outer package size: 1250 * 640 * 900mm	

Single chamber vacuum machine	
DZ-500/2E 700USD	
Power: 0.75kw;Voltage/frequency: 110-120v / 60hz	
Vacuum pressure: 1.33 mpa	
Heat seal width: 10 mm	
Vacuum displacement: 20 m ³ /hr	
Vacuum chamber size: 520 * 500 * 50MM	
Machine size: 610 * 520 * 980mm	
Gross weight/net weight:160/140 kgs	
Outer package size: 680 * 680 * 1000mm	

Double chamber vacuum machine	
DZ-500/2SB 1,500USD	
Power: 1.5kw;Voltage/frequency: 3 phase 220v / 60hz	
Vacuum pressure: 1.33 mpa	
Heat seal width: 10 mm	
Vacuum displacement: 40 m ³ /hr	
Vacuum chamber size: 560 * 540 * 50MM (unilateral)	
Machine size: 1250 * 610 * 1000mm	
Gross weight/net weight:220/180 kgs	
Outer package size: 1340 * 750 * 1100mm	

Single chamber vacuum machine	
DZ-600/2E 1,100USD	
Power: 1.5kw;Voltage/frequency: 110-120v / 60hz	
Vacuum pressure: 1.33 mpa	
Heat seal width: 10 mm	
Vacuum displacement: 20 m ³ /hr	
Vacuum chamber size: 630 * 650 * 65MM	
Machine size: 730 * 710 * 960mm	
Gross weight/net weight:180/160 kgs	
Outer package size: 780 * 780 * 1050mm	

Double chamber vacuum machine	
DZ-600/2SB 1,800USD	
Power: 1.5kw;Voltage/frequency: 3 phase 220v / 60hz	
Vacuum pressure: 1.33 mpa	
Heat seal width: 10 mm	
Vacuum displacement: 63 m ³ /hr	
Vacuum chamber size: 660 * 540 * 50MM (unilateral)	
Machine size: 1450 * 610 * 950mm	
Gross weight/net weight:250/220 kgs	
Outer package size: 1540 * 750 * 1100mm	

Note: The desktop model cannot be deepened.

Verticalmodel can be deepened (generally 12, 20, 25, 30 cm, four depths).

If deepened, The cost of single room is US\$50, and that of double rooms is US\$100.

Bottom mounted series–Reach in refrigerator & freezer

- Precision ventilated refrigeration system keeps food at safe temperature.
- Electronic control system makes it easy to adjust temperature set point and defrost frequency.
- Self-closing doors with 90 degree stay-open feature.Locks and keys included.
- Preinstalled heavy duty casters with brakes.
- Removeable installation board makes it easy to access condenser coil for cleaning and service.
- Stainless steel exterior and interior,ensure longer life.



CR-23B / CF-23B



CR-49B / CF-49B

Model	Temperature	Shelves	Dimesnion (WxDxH) inch / mm	Capacity Cu.ft. / Liters
CR-23B 600USD	33°F~41°F 0.5°C~5°C	4	26.9x32x81.9 683x815x2080	20 560
CF-23B 640USD	-8°F~0°F -22.2°C~-17.7°C	4	26.9x32x81.9 683x815x2080	20 560

Model	Temperature	Shelves	Dimesnion (WxDxH) inch / mm	Capacity Cu.ft. / Liters
CR-49B 800USD	33°F~41°F 0.5°C~5°C	8	54.1x32x81.9 1375x815x2080	43 1220
CF-49B 840USD	-8°F~0°F -22.2°C~-17.7°C	8	54.1x32x81.9 1375x815x2080	43 1220

Chiller / Freezer



	450L 2 Door	900L 4 Door	1300L 6 Door
500USD	Model: YD-2A Direct Cooling 0 - 10 °C	680USD	Model: YD-6A Direct Cooling 0 -10 °C
540USD	Model: YD-2B Direct Cooling -15 - -5 °C	700USD	Model: YD-6B Direct Cooling -15 - -5 °C
580USD	Model: YD-2C Top doors 0 - 10 °C Bottom doors -15 - -5 °C	740USD	Model: YD-6C Top doors 0 - 10 °C Bottom doors -15 - -5 °C
750USD	Model: YD-2D Air Cooling 0 - 10 °C	950USD	Model: YD-6D Air Cooling 0 - 10 °C
830USD	Model: YD-2E Air Cooling -15 - -5 °C	1,050USD	Model: YD-6E Air Cooling -15 - -5 °C

Remark: All CR, CF and YD series models can do glass door

The default stainless steel door

If you need the glass door

Please inform us



Pizza /Salad Prep Chiller Table



CC-150-S1 / CC-180-S1



CC-150-S2 / CC-180-S2



CC-150-S3 / CC-180-S3



CC-150-S4 / CC-180-S4



CC-150-S5 / CC-180-S5



CC-150-S6 / CC-180-S6

Item Name	Model Number	Specification
1.5M Pizza/ Salad Prep Chiller With GN Pans	CC-150-S1 1,300USD	1500*800*1080mm 201SS frame,304SS GN trays With 7 * 1/3GN Pans at top Cabinet inner Temperature -10 - 0℃ Top layer boxes 0 - 5 ℃ Deisgn as pictures Air cooling
	CC-150-S2 1,350USD	
	CC-150-S3 1,350USD	
	CC-150-S4 1,350USD	
	CC-150-S5 1,350USD	
	CC-150-S6 1,350USD	
1.8M Pizza/ Salad Prep Chiller With GN Pans	CC-180-S1 1,500USD	1800*800*1080mm 201SS frame, 304SS GN trays With 8* 1/3GN Pans at top Cabinet inner Temperature -10 - 0℃ Top layer boxes 0 - 5 ℃ Deisgn as pictures Air cooling
	CC-180-S2 1,550USD	
	CC-180-S3 1,550USD	
	CC-180-S4 1,550USD	
	CC-180-S5 1,550USD	
	CC-180-S6 1,550USD	

Chef Base Refrigerator-CB Series



BN-CC13R2-T1
1,250USD



BN-CC13R2-T2
1,600USD



BN-CC18R3-T
2,000USD

Model	Dimension(W*D*H/mm)	GN PANS	Temperature(℃)	Cooling System	Net Capacity(L)	Refrigerant	Power Input	Voltage
BN-CC13R2-T1	924x816x645	2*1/1+6*1/6	0.5℃~+5℃	Ventilated	167	R134a	205W	220/50Hz
BN-CC13R2-T2	1318x816x645	6*1/1	0.5℃~+5℃	Ventilated	280	R134a	220W	220/50Hz
BN-CC18R3-T	1839x816x645	8*1/1	0.5℃~+5℃	Ventilated	425	R134a	230W	220/50Hz

Working Counter Table Chiller / Freezer



CC-180-1
1,100USD



CC-180-2
1,200USD



CC-180-3
1,200USD



CC-180-4 1,200USD



CC-180-5 1,200USD



CC-180-6 1,200USD

Item Name	Model Number	Specification
1800mm 3 door counter chiller	CC-180-1	1800*700*900mm, 110/220V, 0-5 ℃, Full body stainless steel, Embraco / Danfoss compressor
1800mm 6 drawer counter chiller	CC-180-2	1800*700*900mm, 110/220V, 0-5 ℃, Full body stainless steel, Embraco / Danfoss compressor
1800mm 1 door + 4 drawer counter chiller	CC-180-3	1800*700*900mm, 110/220V, 0-5 ℃, Full body stainless steel, Embraco / Danfoss compressor
1800mm 2 drawer+ 2 door counter chiller	CC-180-4	1800*700*900mm, 110/220V, 0-5 ℃, Full body stainless steel, Embraco / Danfoss compressor
1800mm 2 door + 2 drawer counter chiller	CC-180-5	1800*700*900mm, 110/220V, 0-5 ℃, Full body stainless steel, Embraco / Danfoss compressor
1800mm 4 drawer+ 1 door counter chiller	CC-180-6	1800*700*900mm, 110/220V, 0-5 ℃, Full body stainless steel, Embraco / Danfoss compressor

The following is our standard model, and also supports customization



Ice Maker



Output 40 - 100 KG /24 H



Output 120 - 180 KG /24 H



Output 200-500 KG /24 H



Output 600-1000 KG /24 H

Item Name	Model Number	Specification
40KG /24H output Ice Maker	300USD IM-40	220/110V, Air cooling , Bin capacity 12KG
50KG /24H output Ice Maker	350USD IM-50	220/110V, Air cooling , Bin capacity 12KG
60KG /24H output Ice Maker	400USD IM-60	220/110V, Air cooling , Bin capacity 12KG
80KG /24H output Ice Maker	500USD IM-80	220/110V, Air cooling / water cooling , Bin capacity 18KG
100KG /24H output Ice Maker	550USD IM-100	220/110V, Air cooling / water cooling , Bin capacity 18 KG
120KG /24H output Ice Maker	650USD IM-120	220/110V, Air cooling / water cooling , Bin capacity 40 KG
150KG /24H output Ice Maker	750USD IM-150	220/110V, Air cooling / water cooling , Bin capacity 40KG
180KG /24H output Ice Maker	850USD IM-180	220/110V, Air cooling / water cooling , Bin capacity 40 KG
200KG /24H output Ice Maker	1, 200USD IM-200	220/110V, water cooling , Bin capacity 150KG
300KG /24H output Ice Maker	1, 600USD IM-300	220/110V, water cooling, Bin capacity 150KG
400KG /24H output Ice Maker	2, 000USD IM-400	220/110V, water cooling , Bin capacity 250KG
500KG /24H output Ice Maker	2, 400USD IM-500	220/110V, water cooling, Bin capacity 250KG
600KG /24H output Ice Maker	3, 000USD IM-600	220/110V, water cooling, Bin capacity 480KG
800KG /24H output Ice Maker	3, 500USD IM-800	220/110V, water cooling , Bin capacity 480KG
1000KG /24H output Ice Maker	4, 000USD IM-1000	220/110V, water cooling , Bin capacity 480KG

Soft Ice Cream Machine

Picture

Model No.

Specification



18L/Hour
2+1 Mixed Flavor
Soft Ice Cream
Machine

JS010-D
750USD

Voltage:220/110V 1.2KW
Dimension(L*W*H): 55*42*76cm
Net weight/gross weight 56/62KG
Material: Stainless Steel
Material Basin Capacity 3L*2
Refrigerating Tank 1.8L*2,
With Self-cleaning function
Panasonic Rotating Compressor
Output:18L/H (200-250 pcs)
R22/410a/404
Air cooling
With computer panel
With built-in air pump
Material shortage alarm function



JS010-E
900USD

Voltage:220/110V 1.25KW
Dimension(L*W*H): 54*41*76cm
Net weight/gross weight 56/62KG
Material: Stainless Steel
Material Basin Capacity 4L*2
Refrigerating Tank 1.8L*2,
With Self-cleaning function
Panasonic Rotating Compressor
Output:18L/H (200-250 pcs)
R22/410a/404
With computer panel
With built-in air pump
Material shortage alarm function
With Pre-cooling Function, keep fresh at night



Do you prefer counter top or free standing type?



20L/Hour
2+1 Mixed Flavor
Soft Ice Cream
Machine

JS010-B
800USD

Voltage:220/110V 1.85KW
Dimension(L*W*H): 60*50*135cm
Net weight 90KG
Material: Stainless Steel
Material Basin Capacity 5.8L*2,
Refrigerating Tank 2L*2,
With Built-in Air Pump,
With Self-cleaning function
Panasonic Rotating Compressor
Output: 20L/H (250-300 pcs)
R22/410a/404
Material shortage alarm function



36L/Hour
2+1 Mixed Flavor
Soft Ice Cream
Machine

JS010
1, 200USD

Voltage:220/110V 2.6KW
Dimension(L*W*H): 72*57.5*138cm
Net weight 110KG
Material: Stainless Steel
Material Basin Capacity 8L*2,
Refrigerating Tank 2L*2,
With Built-in Air Pump,
With Pre-cooling Function, keep fresh at night ,
With Self-cleaning function
Panasonic Rotating Compressor
Output: 36L/H (400-500 pcs)
R22/410a/404
Material shortage alarm function







48L/Hour
2+1 Mixed Flavor
Soft Ice Cream
Machine



JS010-A
1, 500USD

Voltage:220V 3.8KW
Dimension(L*W*H): 76*57*150cm
Net weight 145KG
Material: Stainless Steel
Material Basin Capacity 8L*2,
Refrigerating Tank 2L*2,
With Built-in Air Pump,
With Pre-cooling Function, keep fresh at night
With Self-cleaning function
With 2 pcs Thailand KK Rotating Compressor
Output: 48L/H (500-600 pcs)
R22/410a/404
Material shortage alarm function

Gelato Maker

NO.	Item Name	Picture	Model	Specification
1	Countertop 18L/H Gelato Hard Ice Cream Machine		ZM-A500 500USD	One key refrigeration Stainless Steel machine body Microprocessor Voltage :220V50Hz/110V60Hz Power :1000W capacity 6L output 18L/H Refrigerant R22/430g N.W. 45KG Product dimension: 55*42*70cm LG Compressor Chain + motor mixing
2	Free Standing 24L/H Gelato Hard Ice Cream Machine		ZM-A580 1,100USD	One key refrigeration Stainless Steel machine body Microprocessor Voltage:220V50Hz/110V60Hz Power :1500W capacity :12L output :24L/H Refrigerant R22/450g N.W. 84KG Product dimension: 60*51*130cm Panasonic compressor Belt + motor mixing
3	Free Standing 36L/H Gelato Hard Ice Cream Machine	 	ZM-A620 1,700USD	One key refrigeration Stainless Steel machine body Microprocessor Voltage: 220V50Hz/110V60Hz Power:1800W capacity: 12L output :36L/H Refrigerant :R404A/450g N.W. 85KG Product dimension: 60*51*130cm Embraco compressor RV + motor mixing

Slushy Machine

	XRJ12x2 700USD	capacity: 12 literx2 voltage: 220V-240V/ 110V-120V, 50HZ/60HZ power: 600W temperature: -2~-3°C product size: 430x510x770mm package size: 465*560*890mm N. W/G. W: 44Kgs/57Kgs
	XRJ12x3 800USD	capacity: 12 literx3 voltage: 220V-240V/ 110V-120V, 50HZ/60HZ power: 800W temperature: -2~-3°C product size: 610x510x770mm package size: 665*555*890mm N. W/G. W: 63Kgs/80Kgs

Drinks Machines

Item Name	Photo	Model No	Specification
One tank juice machine		DN312 250USD	Machine Dimension 265*375*700mm Net weight 15kg Power 145W 0-8 °C Capacity 16L 110/220V, 50-60Hz
2 tank juice machine		DN325 300USD	Machine Dimension 420*450*680mm Net weight 26kg Power235W 0-8 °C Capacity 16L*2 110/220V, 50-60Hz
3 tank juice machine		DN338 350USD	Machine Dimension 620*450*680mm Net weight 36kg Power 330W 0-8 °C Capacity 16L*3 110/220V, 50-60Hz
3 head soda beverage machine		3F3B 800USD	Dimension:340*670*810mm Net weight 58KG 110/220V 50-60Hz Power 720W Refrigeration: R134a Sikelan compressor Carton with foam package Carton size: 400*740*880mm Caron weight 60KG With CE
Soda Making Machine 4 Head		4F4B 900USD	340*670*810mm 720W Sporland compressor, fast refrigeration speed, all-copper enlarged condenser, stable system, frosted plate, imported food-grade pipes, high gas content, good puffing effect, excellent taste, excellent quality!

All in JOY-Equipment

Commercial Dishwashers

1,400 USD

If need

tables and sink

plus 300USD



Model: EU-60E

1,100 USD



Model: ET-50B

Hood type dishwasher

Model No.	EU-60E	Maximum washing capacity	60 baskets / hour
Dimensions	725 * 843 * 1522mm	Washing temperature	60-65 °C
Maximum water consumption	108L / hour	Machine entrance width	508mm
Rinse temperature	82-92 °C	Maximum washing height	450mm
Heater volume	22L	Water tank volume	21L
Washing cycle	60/90/120 seconds	Heating method	Electric / Steam
Inlet diameter	6 points	Inlet pressure	0.12-0.15Mpa
Voltage	380V / 220V	Inlet pipe diameter	6 points
Water hardness	0.034-0.103G /L	Total power	15.8KW

Minimum cross section of power cord 6 mm²

Product Description

- **Main applicable places:** restaurants / cafes / bars with about 200 people
- Independent high-temperature water tank with high temperature up to 82-92 °C, more complete disinfection
- Patented design spraying arm. The upper and lower washing arms spray without dead angle
- One key to start, easy to use, reduce user requirements
- The heater is made of 316 material. High thermal efficiency. Durable
- Material and performance description: The whole machine mechanism and accessories are made of SUS304 material and imported plastics. The intelligent control system has stable performance and one-click start to make the user's operation easier. The electrical components are all **French Schneider and OMRON** to ensure electronic control Quality, **(two free baskets for dishwashers)**

All machines come with 2 baskets, one for dishes, one for glass cups

ET-50B Undercounter Dishwasher

- 1) Equipment name: under counter dishwasher
- 2) Equipment model ET-50B
- 3) Overall dimension: 600X600X800mm
- 4) Washing capacity: 20~60 baskets/hour
- 5) Maximum washing height: 320mm
- 6) Washing heating power: 1.7KW
- 7) Spray heating power: 7.5KW/380V OR 2.5KW/220V
- 8) Power of cleaning water pump: 0.37KW
- 9) Maximum water consumption per hour: 168L
- 10) Maximum water consumption: 2.5L/basket
- 11) Water tank volume: 19L
- 12) Cleaning temperature: 55-65 °
- 13) Spray temperature: 82-90 °
- 14) Size of tableware basket: 500 * 500mm



Dish/Cup



Stainless Steel Kitchen Items, Welcome Customize

Item Name	Picture	Dimension (mm)
Stainless Steel Working Table		70USD 1200*600*800
		90USD 1500*600*800
		100USD 1800*600*800
		110USD 1500*800*800
		120USD 1800*800*800
Stainless Steel Shelves		80USD 800*500*1500
		90USD 1000*500*1500
		100USD 1200*500*1500
		110USD 1500*500*1500
		125USD 1800*500*1500
		150USD 2000*500*1500
Stainless Steel Sinks		90USD 900*500*800+150
		100USD 1000*550*800+150
		110USD 1100*600*800+150
		120USD 1200*650*800+150
		150USD 1400*760*800+150
Stainless Steel Sinks		120USD 1300*500*800+150
		130USD 1450*550*800+150
		140USD 1600*600*800+150
		150USD 1750*650*800+150
		210USD 2050*750*800+150